

MRT500.12-416F3

On-state voltage Vs. peak on-state current

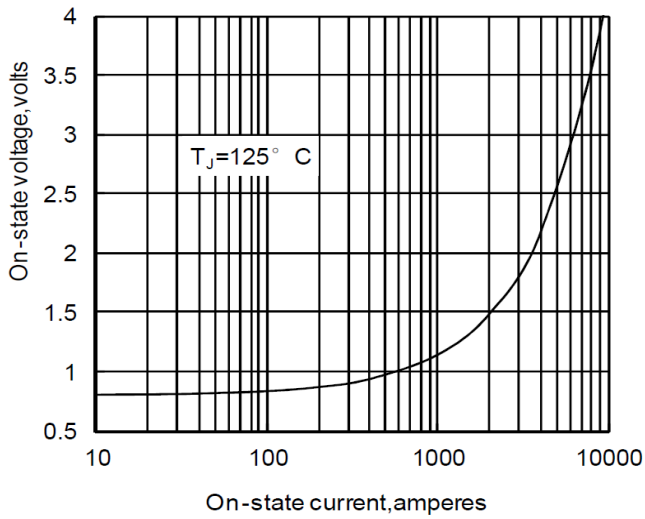

Fig1

Max. junction to case thermal impedance Vs. time

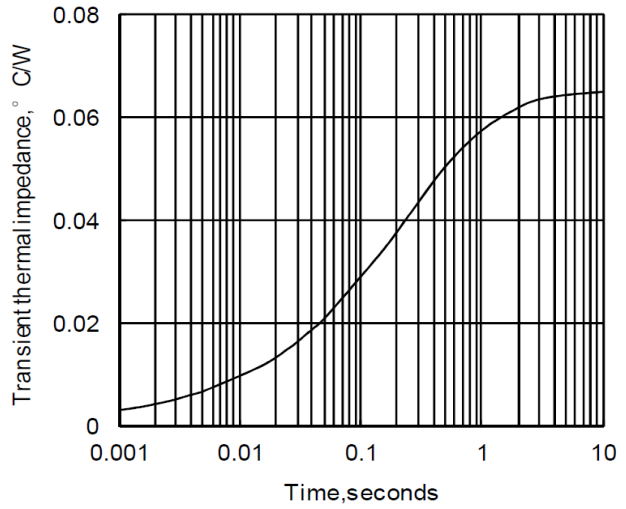

Fig2

Max. power dissipation Vs. mean on-state current

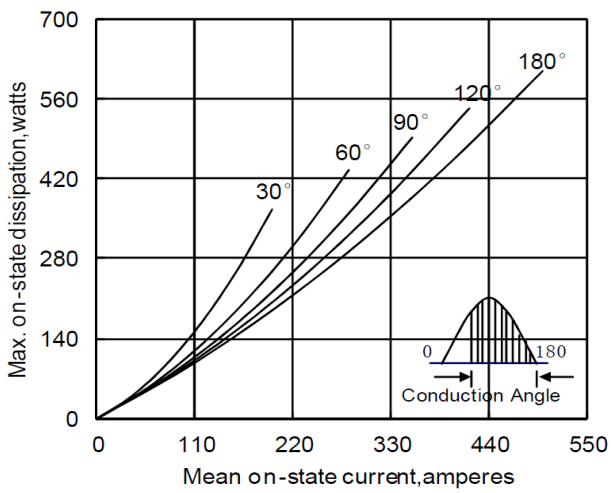

Fig3

Max. case temperature Vs. mean on-state current

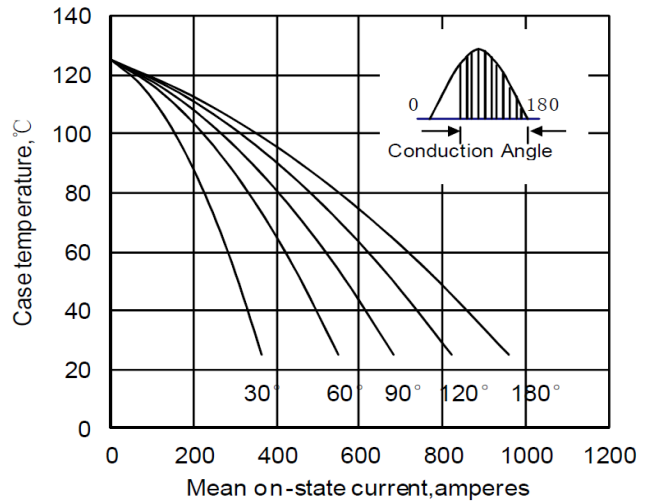

Fig4

Max. power dissipation Vs. mean on-state current

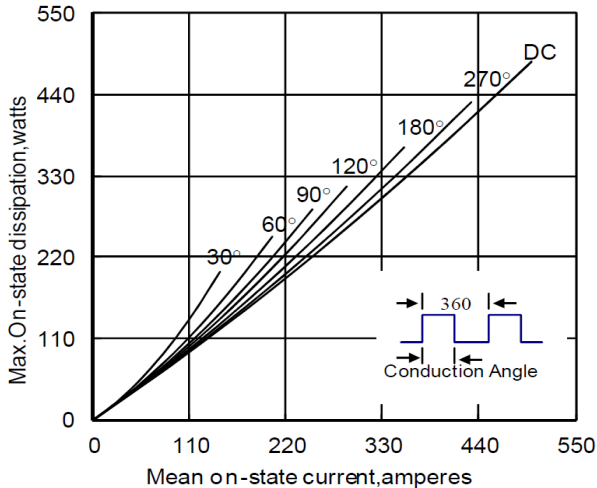

Fig5

Max. case temperature Vs. mean on-state current

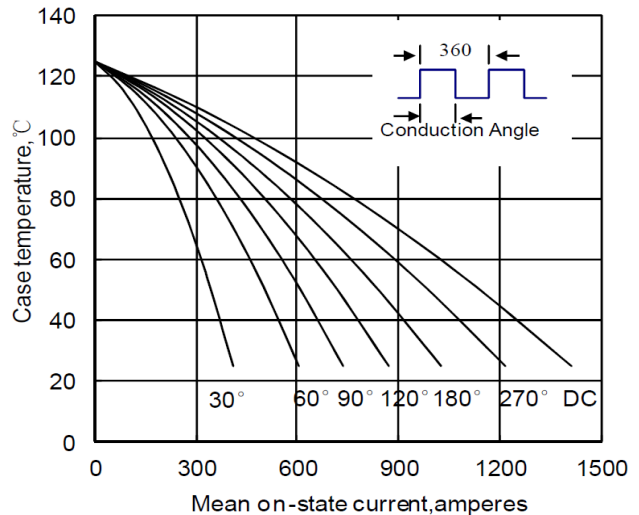

Fig6

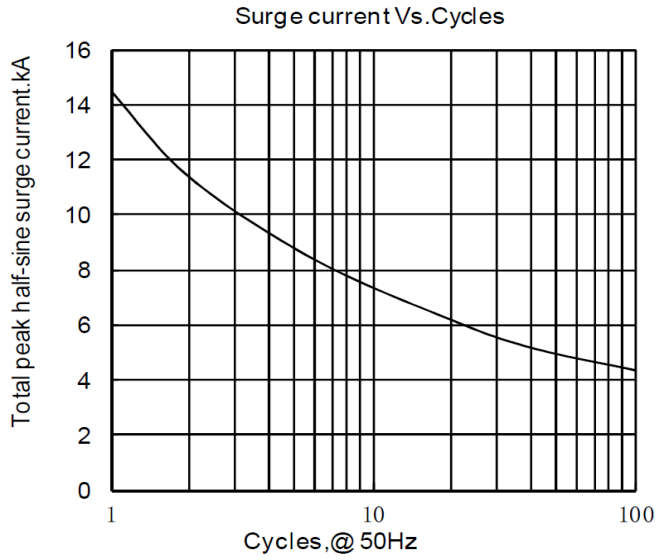

Fig7

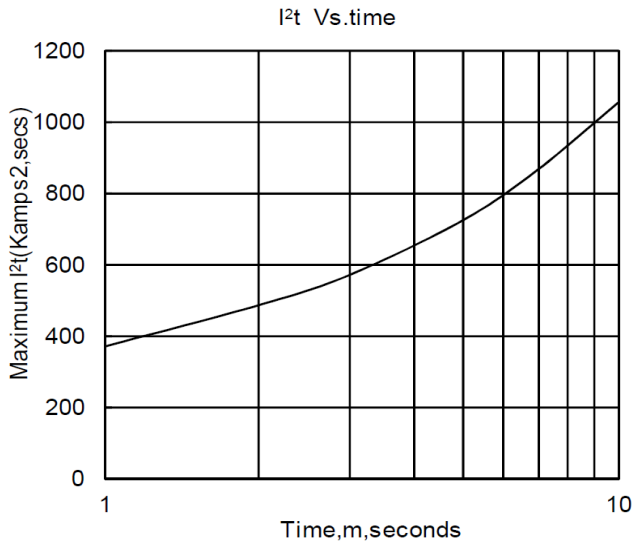

Fig8

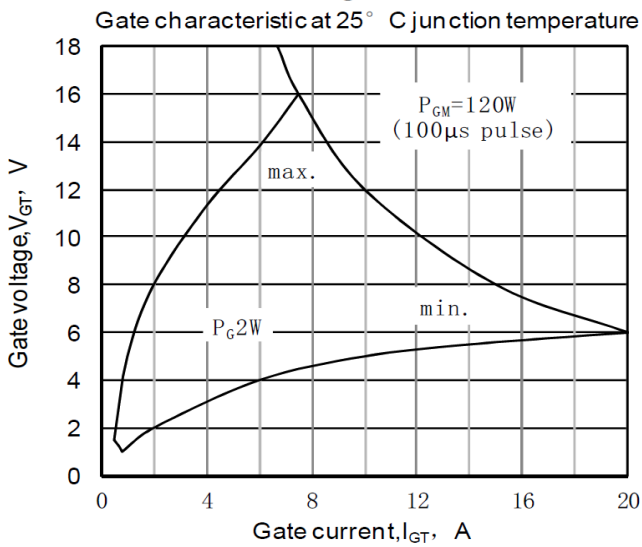

Fig9

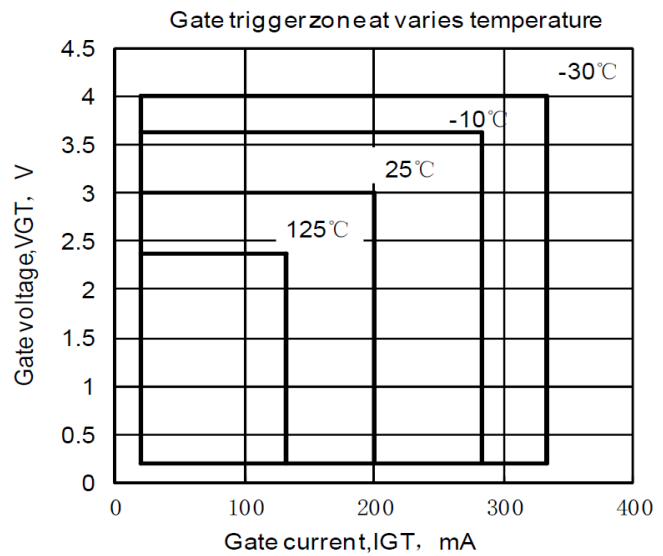
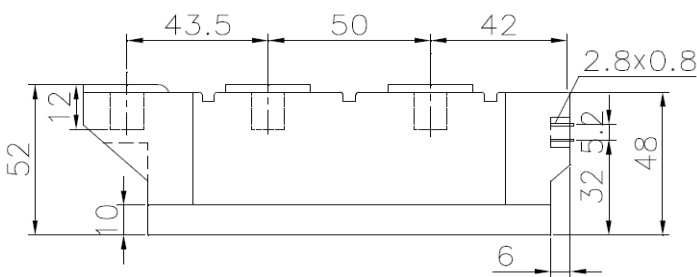
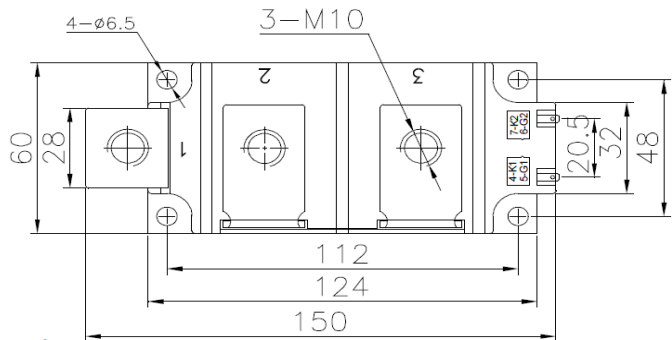

Fig10



(dimensions in mm)



S.CO.M.E.S. Srl

Via Enrico Mattei, 6/8 - 26283 - Castiglione d'Adda (LO) - Italy

Phone: +39 0377 901243 Fax: +39 0377 900206